

















# Jumbo Air

 **120 L x 80 W x 40/46 H cm**     **1050008**

Nr.			x	Nr.			x
2801	372 mm		4	2613	180 mm		4
2803	1172 mm		2	m7	18 mm		12
2805	368 mm		4	a7	M6x4.8		4
2806	376 mm		2	a8	M6		4
2807	376 mm		2	a10	Φ3.5x13		56
2812	376 mm		8	a18	M4x25		4
2817	1172 mm		2	a5	M4		4
2808	437 mm			2	a9	M4-S	
2809	1200 mm		1	H	367 mm		2
2811	598 mm		4	A	585x367 mm	4mm Glass	4
2815	598 mm		4	B	367x373/437 mm		4
2814	323 mm		2	C	597x375 mm		4

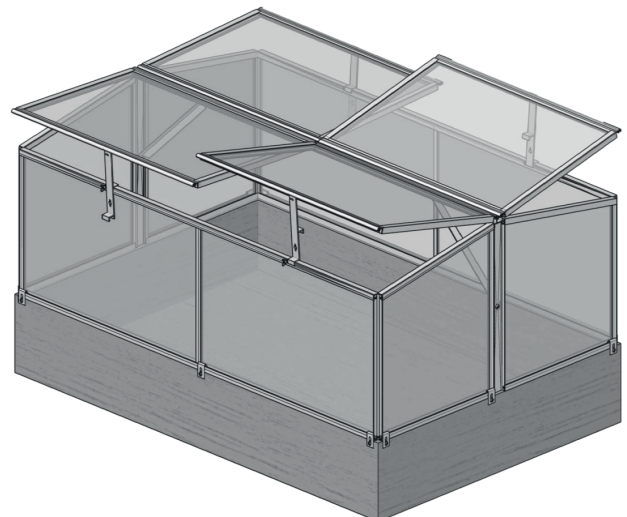
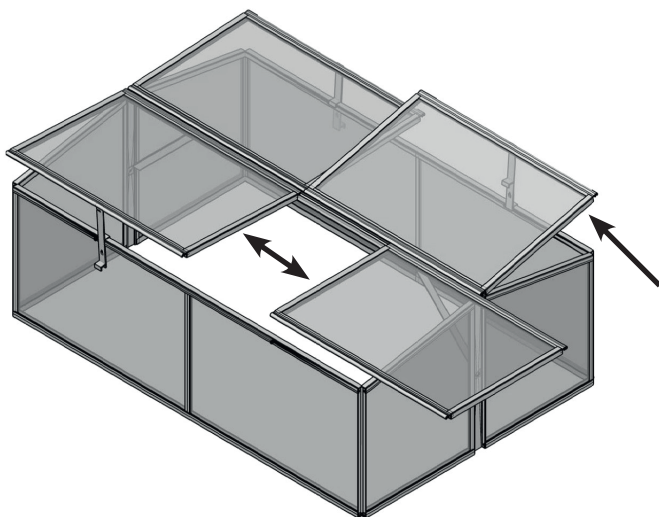

Exclusief het houten frame – Hors occature bois -  
Ohne den Holzrahmen – Excluding the wooden base

1. Dakramen - Fenêtres - Dachfenster - Windows

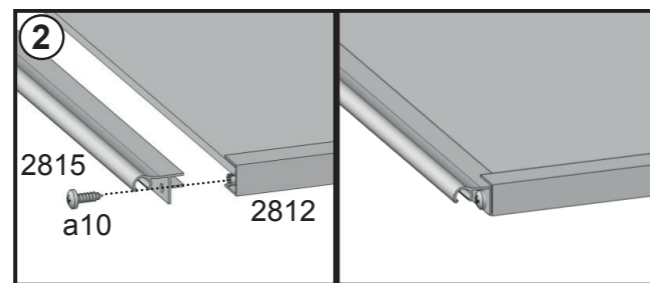
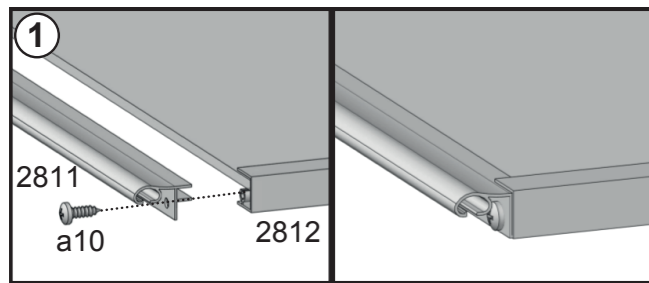
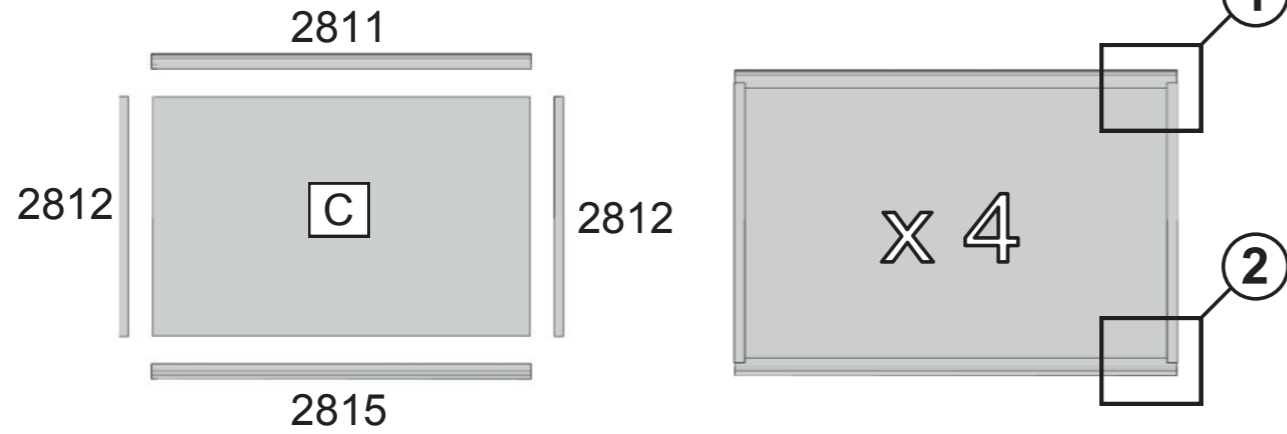

a10 = zelftappende schroef - a10 = vis autotaraudeuse -  
a10 = selbstschneidende Schrauben - a10 = self tapping screw

2. Zijkanten - Cotés - Seiten - Sides

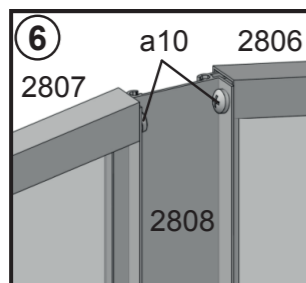
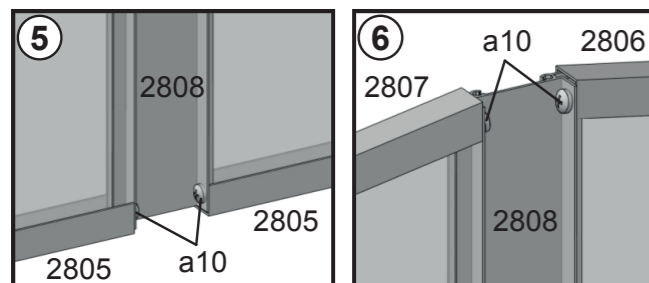
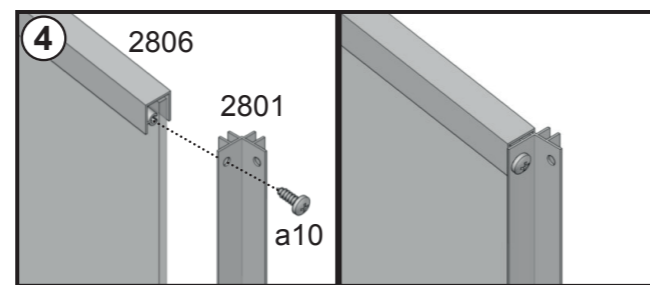
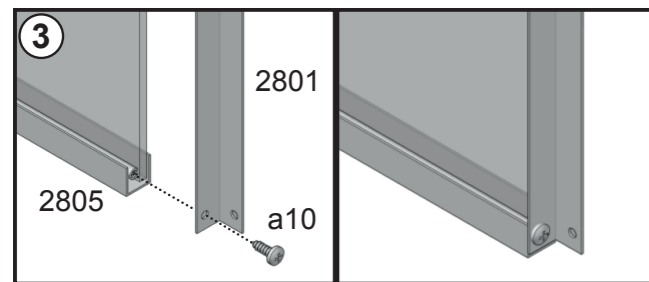
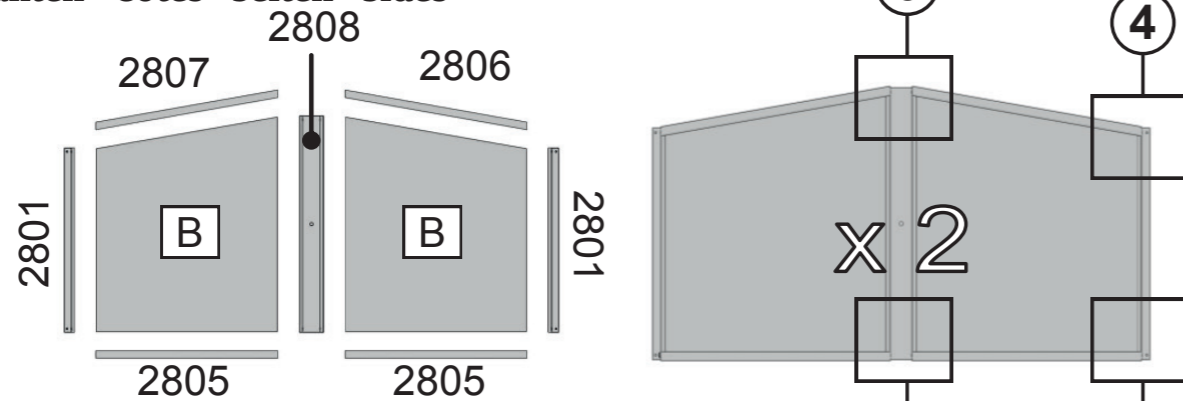

3. Montage frame - Cadre de montage - Montagerahmen - Mounting frame

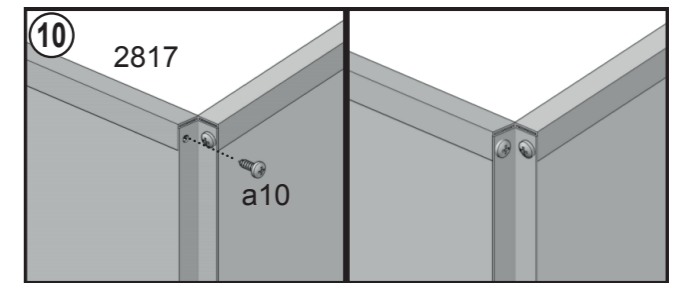
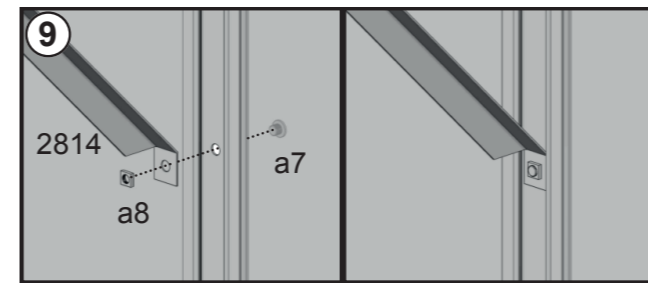
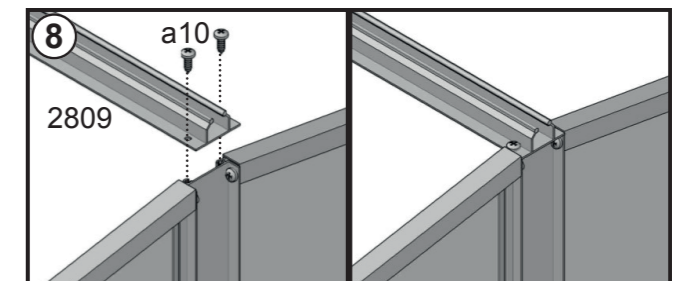
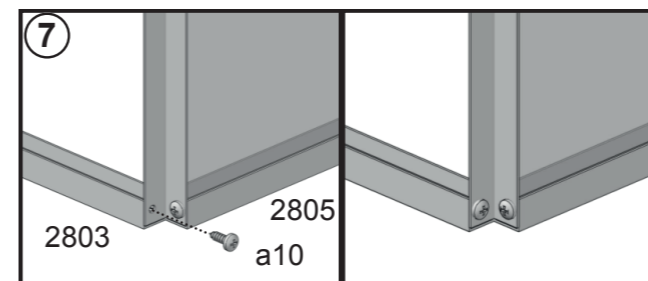
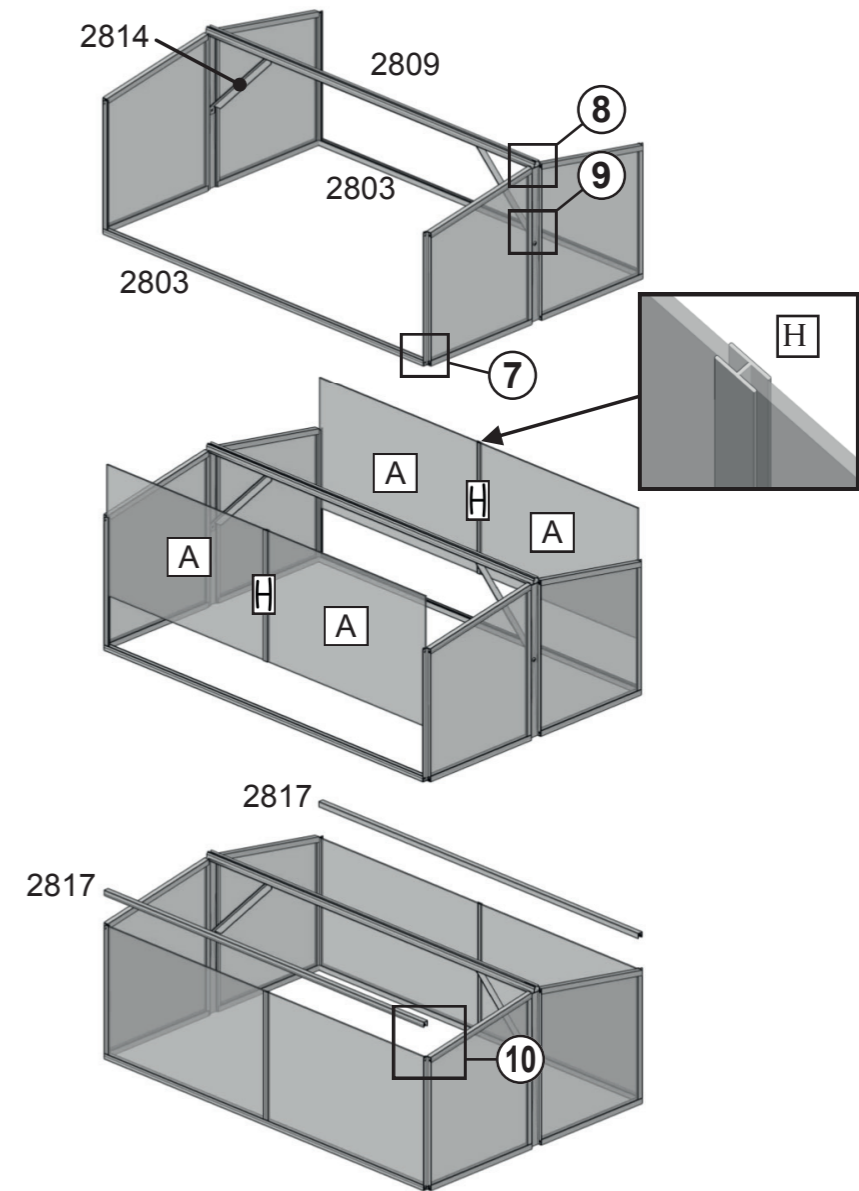

4. Borgen - Sécurisé - Sicher - Secure

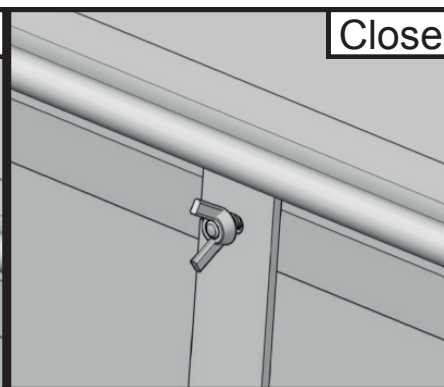
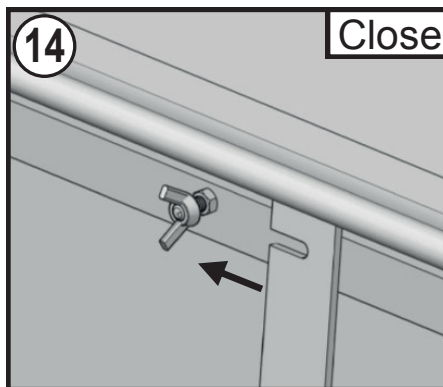
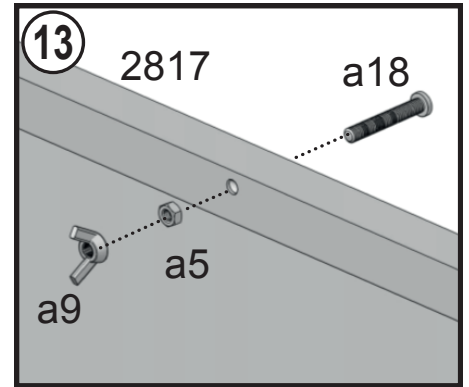
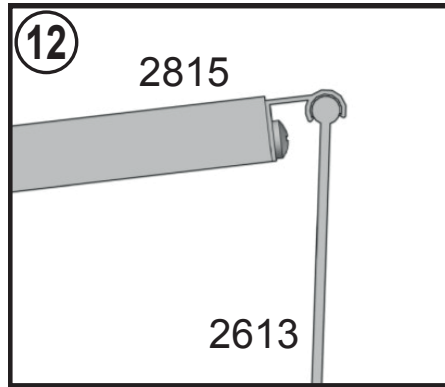
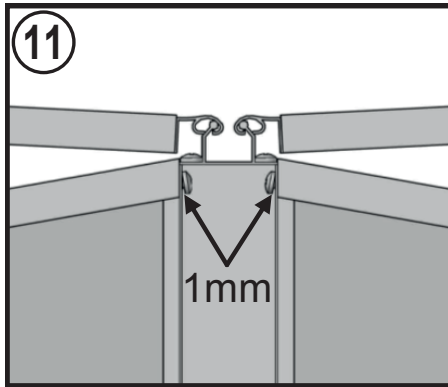

Op slot  
Bloquer  
Sperren  
Lock

